

Article number: 12701000100110

Description: KLEE-coil 701 000 100.110
M10 Unhardened, zinc-pl. & chr. blue

Measures

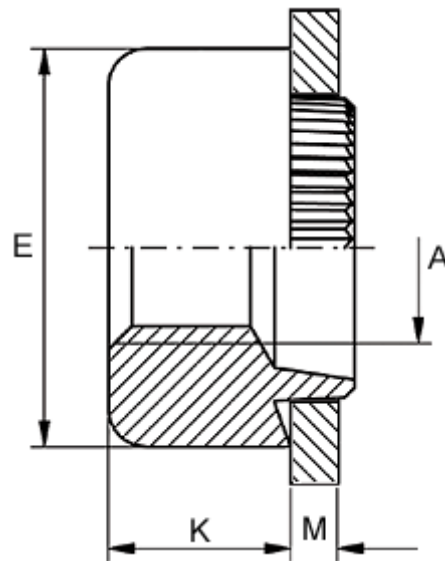

Female thread A	= M10
Height K	= 8.0
Outer diameter E	= 19.0
Plate thickness	= 0.5 to 0.6
Recommended bore diameter for extreme load	= 15.0
Recommended bore diameter for normal use	= 16.0